

HiLoad™ 16/600 and 26/600 Superdex™ 30 prep grade

HiLoad 16/600 and 26/600 Superdex 75 prep grade

HiLoad 16/600 and 26/600 Superdex 200 prep grade

Introduction

HiLoad 16/600 and 26/600 Superdex 30 prep grade, HiLoad 16/600 and 26/600 Superdex 75 prep grade, and HiLoad 16/600 and 26/600 Superdex 200 prep grade (pg) are prepacked XK columns designed for preparative size exclusion chromatography.

Superdex prep grade is a composite matrix of dextran and cross-linked agarose. The steep selectivity of dextran and the high chemical and physical stability of agarose enable high resolution separations. Steep selectivity curves give unmatched resolution for biomolecules in the molecular weight range up to ~ 10 000 for Superdex 30 pg, ~ 3000 to 70 000 for Superdex 75 pg, and ~ 10 000 to 600 000 for Superdex 200 pg (Fig 2).

The chromatography resins combines high mechanical strength with high hydrophilicity, allowing high flow rates and minimal non-specific interactions.

Table 1: Contents of the delivery box

Component	No. supplied
Transport device	1
1/16" male connectors	2
Stop plug	1
HiLoad column	1
Instructions	1

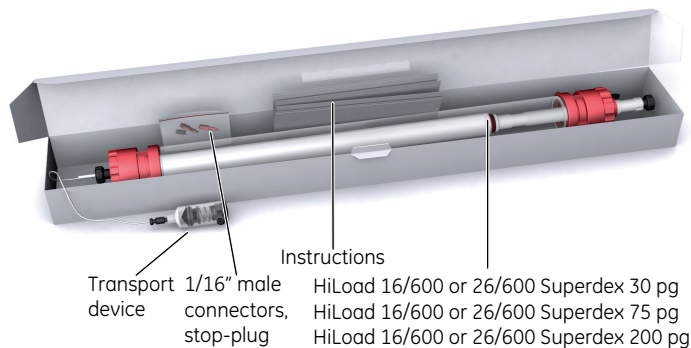

Fig. 1 Package includes HiLoad column, transport device, two connectors, two stop plugs and instructions.

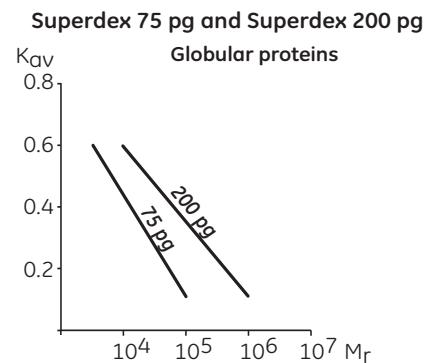
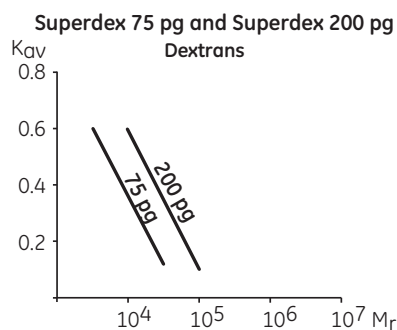
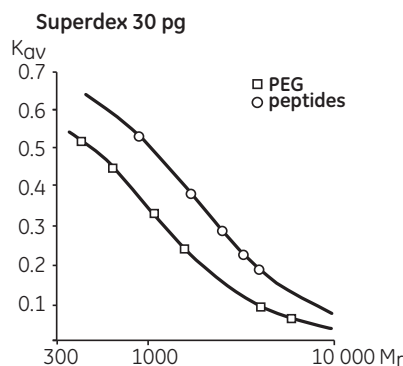

Fig. 2 Selectivity curves from Superdex 30 pg, Superdex 75 pg and Superdex 200 pg.



Table 2: HiLoad column characteristics

Matrix	Cross-linked agarose, spherical
Particle size, d_{50V}^1	~ 34 μm
Fractionation range (M_r)	< 10 000 (Superdex 30 pg)
Globular proteins	~ 3×10^3 to 7×10^4 (Superdex 75 pg) ~ 1×10^4 to 6×10^5 (Superdex 200 pg)
Dextrans	~ 5×10^2 to 3×10^4 (Superdex 75 pg) ~ 1×10^3 to 1×10^5 (Superdex 200 pg)
Column volume ²	120 to 124 mL (16/600) 319 to 330 mL (26/600)
Sample volume ³	Up to 5 mL (16/600) Up to 13 mL (26/600)
Theoretical plates	> 13 000 m^{-1}
Maximum operating pressure, Δp	0.3 MPa (3 bar, 42 psi)
Column hardware pressure limit ⁴	0.5 MPa (5 bar, 73 psi)
pH stability, operational ⁵	3 to 12
pH stability, CIP ⁶	1 to 14
Storage:	
- Superdex 30	- 0.2 M sodium acetate, 20% ethanol at 4°C to 30°C
- Superdex 75	- 0.2 M sodium acetate, 20% ethanol at 4°C to 30°C
- Superdex 200	- 20% ethanol at 4°C to 30°C

¹ Median particle size of the cumulative volume distribution.
² The surface of the resin is not directly visible at the bottom piece. Therefore, when calculating the total column volume, calculate the height of the resin from the lowest part of the bottom piece to the surface of the resin/adaptor.
³ For HiLoad 16/600 deduct 30 mm, and for HiLoad 26/600 deduct 36 mm.
⁴ Optimal sample volume depends on the complexity of the sample and the flow rate. If the sample contains substances with small differences in size, either decrease the sample volume, or decrease the flow rate (in very difficult cases, it may be necessary to decrease both).
⁵ See "Adjusting pressure limits in chromatography system software".
⁶ pH range where resin can be operated without significant change in function.
 pH range where resin can be subjected to cleaning- or sanitization-in-place without significant change in function.

First time use

Connecting the column

- Before connecting the column to a chromatography system, start the pump to remove any air bubbles from the system, particularly in the tubing and valves.
- Stop the pump.
- Mount the column vertically, remove the stop plug and connect the inlet tubing to the system "drop-to-drop".
- Remove the transport device and connect the column outlet tubing to, for example, a monitor cell. Save the transport device for use when storing the column. The column is now ready for use.

Equilibrating the column

Tip: Equilibrate the column a day before usage to save time.

Make sure that an appropriate pressure limit has been set. Equilibrate the column for first time use, or after long-term storage as follows:

- One column volume (CV) of low ionic strength buffer at 1 mL/min for 16/600 or 2.6 mL/min for 26/600.
- Two CV buffer, for example, 0.05 M sodium phosphate, 0.15 M NaCl, pH 7.2 at 1.6 ml/min for 16/600 or 4.3 ml/min for 26/600.

Recommended running conditions

Recommended operating flow rate ¹	1 mL/min for 16/600 or 2.6 mL/min for 26/600
Sample volume	0.5% to 4% of the CV (0.6 to 4.8 mL for 16/600 or 1.6 to 12.8 mL for 26/600) Note: Sample volume is critical for the separation.
Sample preparation	Dissolve the sample in running buffer, filter through 0.22 μm filter or centrifuge at 10 000 $\times g$ for 10 min
Buffer	0.05 M NaPO_4 , 0.15 M NaCl, pH 7.2 or select a buffer appropriate for the next purification step. To avoid pH dependent nonionic interactions with the matrix, include at least 0.15 M salt in the buffer (or use a buffer with equivalent ionic strength).
Regeneration	Regenerate the column after each run with one CV of running buffer at 1 mL/min for 16/600 or 2.6 mL/min for 26/600

¹ At room temperature in H_2O

Read "Optimizing" for information on how to optimize a separation.

Note: When running under cold conditions or using buffer with high viscosity, adjust the flow rate so that the back pressure limit is not exceeded.

Delivery and storage

The prepacked column is delivered in 0.2 M sodium acetate, 20% ethanol (Superdex 30 and Superdex 75) or 20% ethanol (Superdex 200). If the column needs to be stored for more than two days after use, wash the column with four CV distilled water, and then equilibrate with four CV 0.2 M sodium acetate, 20% ethanol or 20% ethanol only, depending on the resin. Use the transport device to prevent air from entering the column and destroying the column packing. Connect the transport device to the capillary tubing at the column outlet. Start the pump and fill the device up to approximately 50% of the total device volume.

Daily use

Stable to commonly used aqueous buffers, pH 3 to 12



Cleaning

Acetonitrile, up to 30%
 NaOH, up to 0.5 M
 Ethanol, up to 70% (Superdex 30 pg)
 Ethanol, up to 24% (Superdex 75 pg and Superdex 200 pg)
 Acetic acid, up to 1 M
 Isopropanol, up to 30%
 Guanidine hydrochloride, up to 6 M
 Urea, up to 8 M
 Hydrochloric acid, up to 0.1 M (Superdex 30 pg)



Avoid

Unfiltered solutions



Buffers and solvent resistance

Degas and filter all solutions through 0.22 μm filter to increase the column lifetime. Buffers and solvents with high viscosity will affect the back pressure and flow rate.

Choosing a buffer

Buffer composition does not directly affect the resolution. Select a buffer that is compatible with the stability and activity of the protein to be purified. Buffer concentration must be sufficient to maintain a buffering capacity and a constant pH. Ionic strength should be at least 0.15 M NaCl in the buffer, to avoid nonspecific ionic interactions with the matrix.

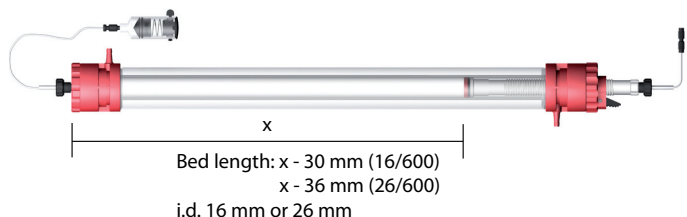

Fig. 3 Dimensions of the column.

Optimizing

Perform a first run as described in "Recommended running conditions". If the results obtained are unsatisfactory, consider the following:

Action	Effect
Decrease flow rate	Improved resolution
Decrease sample volume	Improved resolution

Figures 4 and 5 demonstrate the influence of sample volume and flow rate on the resolution.

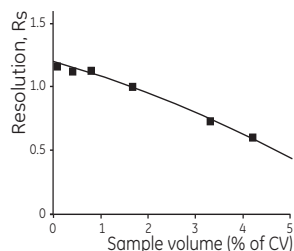

Column: HiLoad 16/600 Superdex 200 pg
 Sample: Solution of transferrin (M_r 81 000) and IgG (M_r 160 000) by equal weight

Sample concentration: 8 mg/mL
 Buffer: 50 mM NaPO₄, 0.1 M NaCl, pH 7.2
 Flow rate: 1 mL/min

Fig. 4 Influence of sample volume on column resolution.

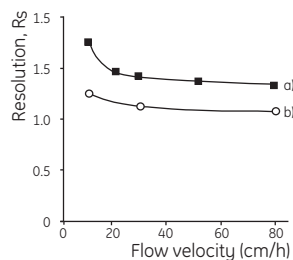

Column: HiLoad 16/600 Superdex 30 pg
 Sample: IGF-1 containing monomers and dimers
 Sample concentration: a) 1.25 mg/mL, b) 5 mg/mL
 Sample volume: 1 mL (0.8% of CV)
 Buffer: 50 mM sodium acetate, 0.1 M NaCl, pH 5.0

Fig. 5 Influence of flow rate on the column resolution.

Column resolution is calculated as:

$$R_s = \frac{2(V_{R2} - V_{R1})}{W_{b2} + W_{b1}}$$

where,

V_{R1} = Retention (elution) volume of the first peak

V_{R2} = Retention (elution) volume of the second peak

W_{b1} = Base width of the first peak

W_{b2} = Base width of the second peak

V_R and W_b in same units.

Cleaning-In-Place (CIP)

Regular cleaning

Wash the column with one-half to one CV 0.5 M NaOH at a flow rate of 0.8 mL/min for 16/600 or 2.2 mL/min for 26/600 to remove most of the nonspecifically bound proteins from the chromatography resin.

After cleaning, immediately equilibrate the column with at least two CV buffer. Further equilibration is necessary if the buffer contains detergents. Wait until the UV baseline stabilizes before starting a new purification.

More rigorous cleaning

Wash the column at a flow rate of 0.8 mL/min for 16/600 or 2.2 mL/min for 26/600 at room temperature with the following solutions:

- 1 Four CV 0.5 M NaOH (removes hydrophobic proteins or lipoproteins) followed by four CV distilled water.
- 2 One-half CV 30% isopropanol (removes lipids and very hydrophobic proteins), followed by two CV distilled water.

Before starting a new purification, equilibrate the column after cleaning with at least five CV running buffer.

Changing the adapter net ring

After following the cleaning procedures above, if the back pressure of the column remains too high, change the net ring in the column adapter. Follow the instructions below thoroughly since column efficiency is easily impaired if handled without care. Use distilled water as a liquid. For an exploded view of the adapter, see Figure 8.

- 1 Close the outlet tubing of the column with a stop plug, and mark the level of the chromatography resin surface on the glass tube using a colored pen.
- 2 Slacken the adapter O-ring slightly by turning the black adjusting knob counter-clockwise.

Note: It should still seal against the glass wall but allow the adapter to slide. Unscrew the top piece from the column.

- 3 Connect the adapter to the pump and start pumping at a flow rate of 1 mL for 16/600 or 2.6 mL/min for 26/600. Allow the flow to push the adapter upwards.
- 4 When the glass tube is completely full, take out the adapter and stop the pump. The glass tube should be completely filled with liquid.
- 5 Change the adapter net ring.
- 6 To avoid any air bubbles under the net, inject 20% ethanol through the adapter using a syringe.
- 7 Insert the adapter into the column at an angle of 45°, avoiding air bubbles. Slide the plunger 1 to 2 cm down and tighten the O-ring. Remove excess liquid completely before screwing the top piece onto the column end piece.
- 8 Remove the syringe and slide down the adapter until it touches the chromatography resin surface. Tighten the O-ring and reconnect the inlet tubing to the system, avoiding air bubbles.

- 9 Remove the stop plug and start the pump. Increase the flow rate until the resin surface is approximately 3 mm above the pen mark. Stop the pump and close the outlet tubing with the stop plug again.

Note: This step requires a pump with high flow rate capacity up to a pressure of 0.5 MPa (5 bar).

- 10 Disconnect the inlet tubing and slacken the adapter O-ring slightly by turning the adjusting knob counter-clockwise. Press the adapter downwards up to the pen mark. Tighten the O-ring.

Note: Do not loosen the O-ring too much as this will result in chromatography resin passing through the O-ring.

- 11 Reconnect the inlet tubing and avoid introducing air into the system.

Troubleshooting

Symptom	Remedy
Increased back pressure over the column	Clean the column according to the section "Cleaning-In-Place (CIP)"
Loss of resolution and/or decreased sample recovery	Clean the column according to the section "Cleaning-In-Place (CIP)"
Air bubbles in the column	Reverse the direction of flow and pump five CV of degassed water through the column at the same flow rate that was used during the run.
Space between adapter and resin	Close the outlet tubing with the stop plug and then disconnect the inlet tubing. Slacken the O-ring slightly by turning the adjusting knob counter-clockwise and push or screw the adapter down until it touches the resin surface. Tighten the O-ring. To maintain an airtight system, reconnect the inlet tubing immediately.

Testing the column efficiency

GE packs columns to the highest standards and each column is thoroughly tested with respect to the number of theoretical plates per meter (N/m) (Fig 6).

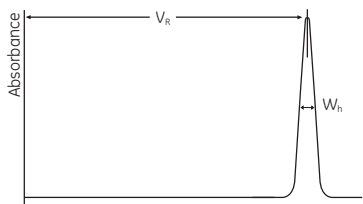

Fig. 6 Column efficiency test

Sample: 2% acetone in water
 Sample volume: 200 µL(16/600) and 500 µl (26/600)
 Eluent: Distilled water
 Flow velocity: 60 cm/h
 Flow rate: 2.0 mL/min (16/600)
 5.3 mL/min (26/600)
 Temperature: Room temperature (25°C)

Column efficiency is calculated using the equation:

$$N/m = 5.54 \times \left(\frac{V_R}{W_h} \right)^2 / L$$

where,

V_R = Peak retention (elution) volume
 W_h = Peak width at half peak height
 L = Bed height (meter)
 V_R and W_h have the same units.

Adjusting pressure limits in chromatography system software

Pressure generated by the flow, through a column, affects the packed bed, and the column hardware, see Figure 7. Increased pressures might be generated when running/using one or a combination of the following conditions:

- High flow rates
- Buffers or sample with high viscosity
- Low temperature
- A flow restrictor

Note: Exceeding the pressure limits (see Table 2) will damage the column.

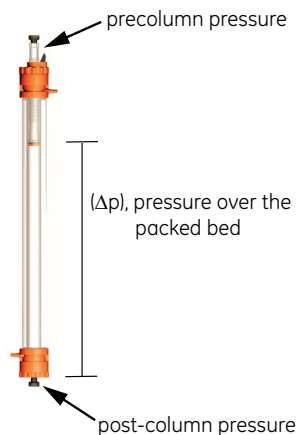

Fig. 7 Precolumn and post-column measurements.

ÄKTA™ avant and ÄKTA pure

The system will automatically handle all pressure limits, which facilitates an optimal functionality without any need of adjustments.

ÄKTAexplorer, ÄKTApurifier, ÄKTAFLC and other systems with pressure sensor in the pump

To obtain optimal functionality, the pressure limits in the software may be adjusted according to the following procedure:

- 1 Replace the column with a piece of tubing. Run the pump at the maximum intended flow rate. Note the pressure as *total system pressure*.
- 2 Disconnect the tubing and run the pump at the same flow rate used in step 1. Note that there will be a drip from the column valve. Note the pressure during this operation as *measured pressure*.
- 3 Calculate *column pressure limit* as a sum of *total system pressure* and Δp (*pressure over the packed bed*) (see Table 2).
- 4 Replace the *column pressure limit* in the software with the calculated value.

Calculate *post-column pressure* as the difference between *total system pressure* and *measured pressure*.

Column hardware pressure limit (see Table 2) must never exceed the sum of *post-column pressure* and Δp .

Note: Repeat the procedure each time the parameters are changed.

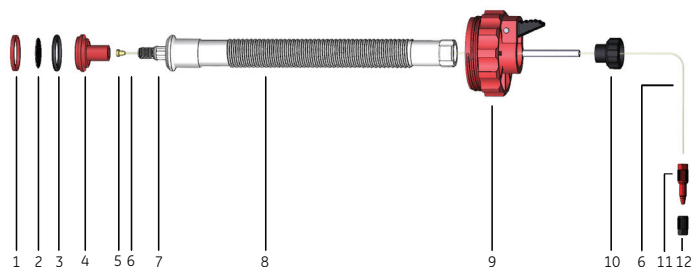

- 1 Net ring
- 2 Support screen
- 3 O-ring
- 4 Plunger
- 5 Ferrule
- 6 Capillary tubing
- 7 Inner shaft
- 8 Adapter shaft
- 9 Top end cap
- 10 Adjusting knob
- 11 HiTrap/HiPrep, 1/16" male connector for ÄKTA design
- 12 Stop plug

Fig. 8 Exploded view of the XK column adapter used at the top of the HiLoad column.

Intended use

HiLoad Superdex columns are intended for research use only, and shall not be used in any clinical or *in vitro* procedures for diagnostic purposes.

Ordering information

Product	Pack size	Code No.
HiLoad 16/600 Superdex 30 prep grade	1 x 120 mL	28989331
HiLoad 26/600 Superdex 30 prep grade	1 x 320 mL	28989332
HiLoad 16/600 Superdex 75 prep grade	1 x 120 mL	28989333
HiLoad 26/600 Superdex 75 prep grade	1 x 320 mL	28989334
HiLoad 16/600 Superdex 200 prep grade	1 x 120 mL	28989335
HiLoad 26/600 Superdex 200 prep grade	1 x 320 mL	28989336

Accessories	No. supplied	Code No.
Accessory kit XK 16*	1	28989978
Accessory kit XK 26*	1	28989979
Support screen XK 16	5	19065101
Support screen XK 26	5	18937701
Net ring (10 µm) XK 16	5	18876101
Net ring (10 µm) XK 26	5	18876001
O-ring XK 16	5	19016301
O-ring XK 26	5	28978227
Stop plug female, 1/16"	5	11000464
HiTrap/HiPrep 1/16" male connector for ÄKTA design	8	28401081
Transport device	1	18117643

* Accessory kits XK 16 and XK 26 are suitable for repacking purposes and contain: 2 support screens, 5 net rings, 2 O-rings, 2 stop plugs, 10 HiTrap/HiPrep 1/16" male connectors for ÄKTA design, and 1 tool for dismantling.

Related literature	Code No.
Size Exclusion Chromatography: Principles and Methods, Handbook,	18102218
Size exclusion chromatography columns and resins, Selection Guide	18112419
Prepacked chromatography columns for ÄKTA systems, Selection Guide	28931778

For local office contact information, visit
www.gelifesciences.com/contact

GE Healthcare Bio-Sciences AB
Björkgatan 30
751 84 Uppsala
Sweden

www.gelifesciences.com/protein-purification

GE, the GE Monogram, ÄKTA, HiLoad, and Superdex are trademarks of General Electric Company.

All other third party trademarks are the property of their respective owner.

© 2001-2018 General Electric Company

All goods and services are sold subject to the terms and conditions of sale of the company within GE Healthcare which supplies them. A copy of these terms and conditions is available on request. Contact your local GE Healthcare representative for the most current information.

GE Healthcare UK Ltd
Amersham Place, Little Chalfont, Buckinghamshire, HP7 9NA, UK

GE Healthcare Bio-Sciences Corp
100 Results Way, Marlborough, MA 01752, USA

GE Healthcare Europe GmbH
Munzinger Strasse 5, D-79111 Freiburg, Germany

GE Healthcare Japan Corporation
Sanken Bldg. 3-25-1, Hyakunincho, Shinjuku-ku, Tokyo 169-0073, Japan

